

XBO® ≤ 450W XENON SHORT ARC

Hi-Tech lamps

800-229-6509

info@hi-techlamps.com

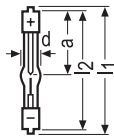

1

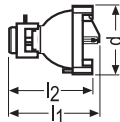

2

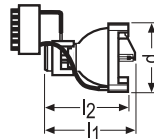

3

Ordering Abbreviation	XBO 75 W/2	XBO 75 W/2 OFR	XBO 100 W OFR	XBO R 100 W/45 OFR	XBO R 100 W/45C OFR
Product Number	69231	69232	69233	69197	69191
Watts (W)	75	75	100	100	100
Volts (V)	14	14	14	13	13
Type of Current	DC	DC	DC	DC	DC
Current (A)	5.4	5.4	7.0	7.0	7.0
Current Control Range (A)					
Lumens (lm)	1000	1000	1900		
Luminous Intensity (cd)	100	100	270		
Average Luminance (cd/cm ²)	40000	40000	31000		
Luminous Area -- w x h (mm)	0.25 x 0.5	0.25 x 0.5	0.4 x 0.8	0.4 x 0.9	0.4 x .09
Length l ₁ max (mm)	90	90	90	83	83
Length l ₂ max (mm)	82	82	82	75	75
Distance a (mm)	43	43	44.5		
Diameter d (mm)	10	10	11	67	67
Avg Rated Life Vertical (hrs)	400	400	500		
Avg Rated Life Horizontal (hrs)	400	400		500	500
Operating Position	s 100	s 100	s 20	p 15	p 15
Forced Cooling			Required	Required	Required
Base Anode	SFa9-2	SFa7.5-2	SFa9-2		
Base Cathode	SFa7.5-2	SFa7.5-2	SFa7.5-2		
Fig No	1	1	1	2	3
Symbols & Footnotes	6,23,29,30,31	6,23,30,31	6,23,30,31,32,33	3,23,30,31,32,33,34,35	3,23,30,31,32,33,35

XBO® ≤ 450W XENON SHORT ARC

hi-Tech lamps

800-229-6509

info@hi-techlamps.com

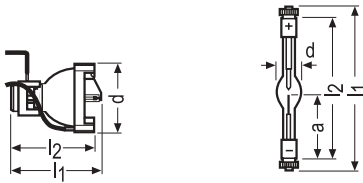

1

2

Ordering Abbreviation	XBO R 101 W/45C OFR	XBO 150 W/1	XBO 150 W/1 OFR	XBO 150 W/4
Product Number	69190	69234	69235	69238
Watts (W)	100	150	150	150
Volts (V)	13	20	20	20
Type of Current	DC	DC	DC	DC
Current (A)	7.0	7.5	7.5	7.5
Current Control Range (A)				
Lumens (lm)		3000	3000	3000
Luminous Intensity (cd)		300	300	300
Average Luminance (cd/cm ²)		15000	15000	15000
Luminous Area -- w x h (mm)		0.5 x 2.2	0.5 x 2.2	0.5 x 2.2
Length l ₁ max (mm)	83	150	150	150
Length l ₂ max (mm)	75	127	127	127
Distance a (mm)		57	57	57
Diameter d (mm)	67	20		20
Avg Rated Life Vertical (hrs)		1200	1200	1200
Avg Rated Life Horizontal (hrs)	500			
Operating Position	p 15	s 15	s 15	s 15
Forced Cooling	Required	Required	Required	Required
Base Anode		SFc12-4	SFc12-4	SFc12-4
Base Cathode		SFcX12-4	SFcX12-4	SFcX12.4
Fig No	1	2	2	2
Symbols & Footnotes	3,32,33,35,36,37	6,23,30,31,38,39	6,23,30,31,39	23,30,31,39,40

PHOTO OPTIC DISCHARGE

XBO® ≤ 450W XENON SHORT ARC

hi-Tech lamps

800-229-6509

info@hi-techlamps.com

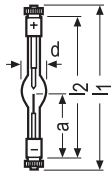

1

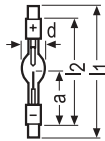

2

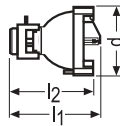

3

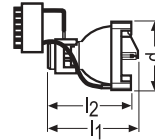

4

Ordering Abbreviation	XBO 150 W/CR OFR	XBO 150 W/S	XBO R 180 W/45/OFR	XBO R 180 W/45C OFR
Product Number	69237	69236	69186	69183
Watts (W)	150	150	180	180
Volts (V)	17.5	20	14	14
Type of Current	DC	DC	DC	DC
Current (A)	8.5	7.5	12	12
Current Control Range (A)				
Lumens (lm)	2900	2200		
Luminous Intensity (cd)	290	220		
Average Luminance (cd/cm ²)	20000	18000		
Luminous Area -- w x h (mm)	0.5 x 1.6	0.5 x 1.9		
Length l ₁ max (mm)	150	117	90	90
Length l ₂ max (mm)	127	96	75	75
Distance a (mm)	57	47.5		
Diameter d (mm)	20	20	67	67
Avg Rated Life Vertical (hrs)	3000	1000	500	500
Avg Rated Life Horizontal (hrs)	1200	800		
Operating Position	s15 p15	s15 p15	p 15	p 15
Forced Cooling	Required	Required	Required	Required
Base Anode	SFc12-4	SFa12-11		
Base Cathode	SFcX12-4	SFa12-11		
Fig No	1	2	3	4
Symbols & Footnotes	3,6,23,30,31,32,41,42	3,6,8,23,30,31,41	3,32,35,43	3,32,35,36

XBO® ≤ 450W XENON SHORT ARC

hi-Tech lamps

800-229-6509

info@hi-techlamps.com

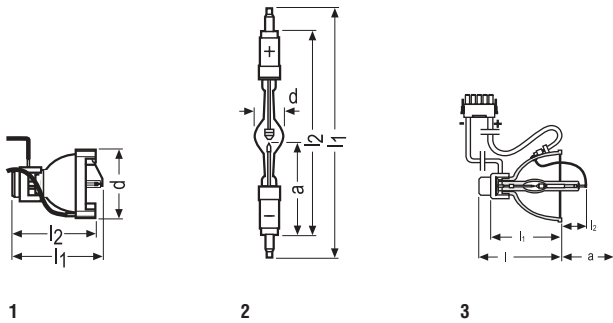

Ordering Abbreviation	XBO R 181 W/45C OFR	XBO 250 W OFR	XBO R 300 W/60C OFR	XBO 450 W
Product Number	69184	69239	69167☼	69241
Watts (W)	180	250	300	450
Volts (V)	14	13	17	17
Type of Current	DC	DC	DC	DC
Current (A)	12	18	16	25
Current Control Range (A)		14-20	14 - 19	17-30
Lumens (lm)		4800		13000
Luminous Intensity (cd)		530		1300
Average Luminance (cd/cm²)		26000		35000
Luminous Area -- w x h (mm)		0.7 x 1.7		0.9 x 2.7
Length l ₁ max (mm)	90	226	62	260
Length l ₂ max (mm)	75	192	30	212
Distance a (mm)		93	60	95.5
Diameter d (mm)	67	25	82.5	29
Avg Rated Life Vertical (hrs)	500	1200		2000
Avg Rated Life Horizontal (hrs)			1000	
Operating Position	p 15	s 15	p20	s 30
Forced Cooling	Required	Required	Required	Required
Base Anode		SFa16-8		SFa20-8
Base Cathode		SFa16-10		SFa20-10
Fig No	1	2	3	2
Symbols & Footnotes	3,32,35,36,37	6,23,30,32,44	3,32,36	6,23,30,44,45,46

PHOTO OPTIC DISCHARGE

XBO® ≤ 450W XENON SHORT ARC

hi-Tech lamps

800-229-6509

info@hi-techlamps.com

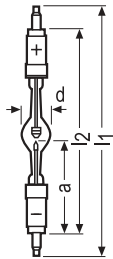

1

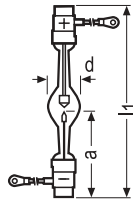

2

Ordering Abbreviation	XBO 450 W OFR	XBO 450 W/1	XBO 450 W/2 OFR	XBO 450 W/4
Product Number	69245	69242	69243	69244
Watts (W)	450	450	450	450
Volts (V)	17	17	17	17
Type of Current	DC	DC	DC	DC
Current (A)	25	25	25	25
Current Control Range (A)	17-30	17-30	17-30	17-30
Lumens (lm)	13000	13000	13000	13000
Luminous Intensity (cd)	1300	1300	1300	1300
Average Luminance (cd/cm ²)	35000	45000	35000	35000
Luminous Area -- w x h (mm)	0.9 x 2.7	0.7 x 2.2	0.9 X 2.7	0.9 x 2.7
Length l ₁ max (mm)	260	260	177	260
Length l ₂ max (mm)	212	212		212
Distance a (mm)	95.5	95.5	79	95.5
Diameter d (mm)	29	29	29	29
Avg Rated Life Vertical (hrs)	2000	800	2000	2000
Avg Rated Life Horizontal (hrs)		800		
Operating Position	s 30	s 100	s 30	s 30
Forced Cooling	Required	Required	Required	Required
Base Anode	SFa20-8	SFa20-8	SK19/36	SFa20-8
Base Cathode	SFa20-10	SFa20-10	SK19/36	SFa20-10
Fig No	1	1	2	1
Symbols & Footnotes	23,30,44	6,23,30,44	6,23,30,32,44	6,23,30,40,44